

E10

D - SUB PCB RIGHT ANGLE (9.4mm) FOOTPRINT : (0.405")

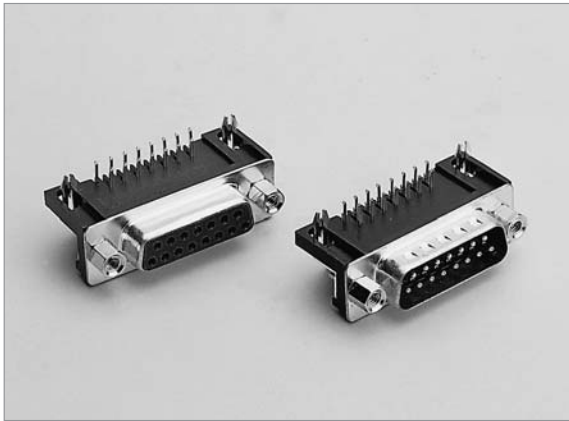

POSITION	A	B	C
9F	16.30	25.00	30.8
15F	24.60	33.30	39.2
25F	38.30	47.10	53.1
37F	54.80	63.50	69.4

POSITION	A	B	C
9M	16.92	25.00	30.8
15M	25.25	33.30	39.2
25M	38.96	47.10	53.1
37M	55.42	63.50	69.4

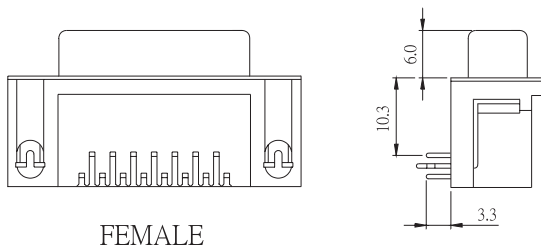
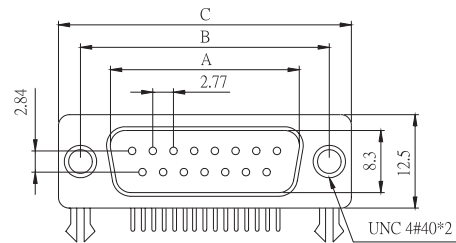
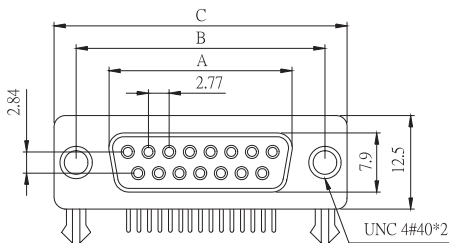

FEMALE

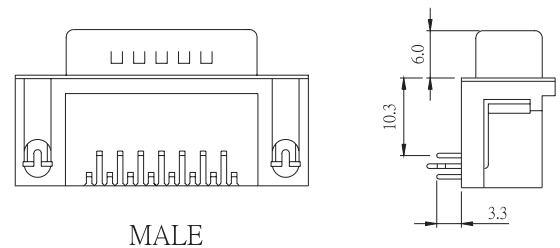

MALE

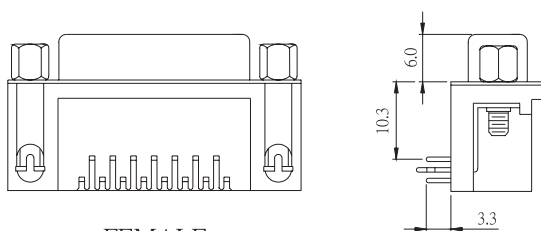
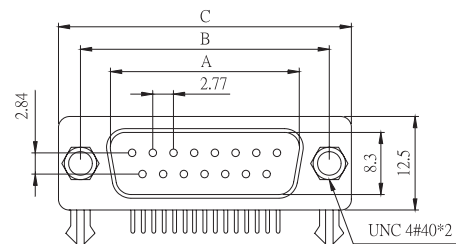
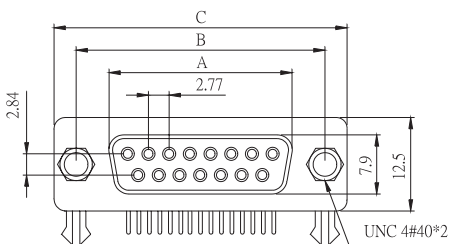

FEMALE

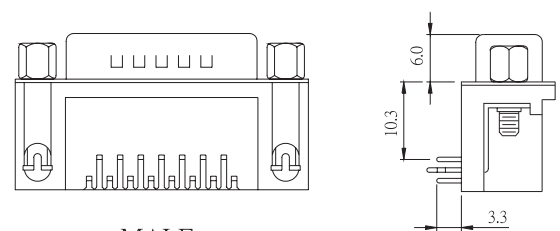

MALE

E10

D - SUB PCB RIGHT ANGLE (9.4mm) FOOTPRINT : (0.405")

PROCESS OPTION

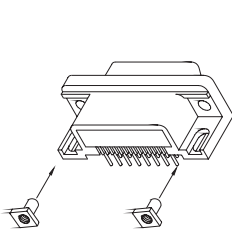

W/RIVET ONLY

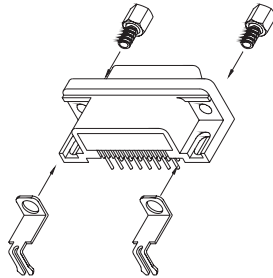

W/BOARDLOCK
SCROW FIXED

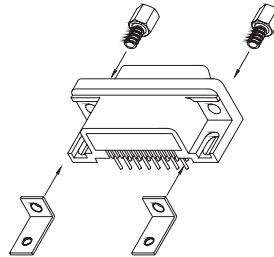

W/NON-THREAD L-SHAPE
SCROW FIXED

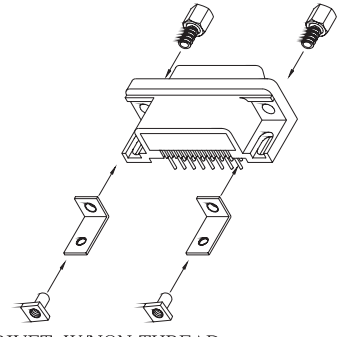

RIVET W/NON-THREAD
L-SHAPE SCROW FIXED

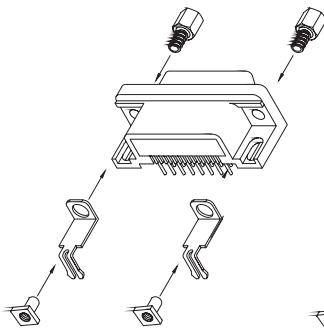

RIVET W/BOARDLOCK
& SCREW FIXED

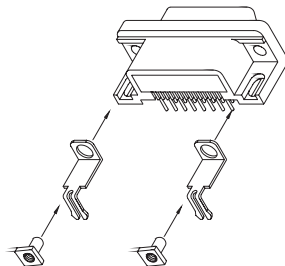

RIVET W/BOARDLOCK

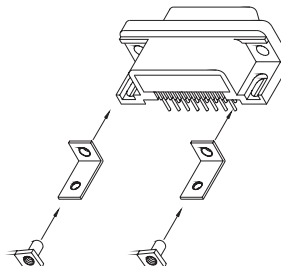

RIVET W/NON-THREAD
L-SHAPE

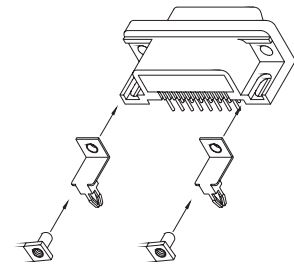

RIVET W/4-PRONG
BOARDLOCK

HOW TO ORDER:

E10 - 1 - 2 - 3 - 4 - 5 - 6 - 7 - 8

1.NO. OF CONTACT	2.CONTACT TYPE	3.CONTACT PLATING	4.SHELL PLATING
09 15 25 37	M: MALE F: FEMALE	T: TIN PLATED S: SELECTIVE G: GOLD FLASH A: 5u" INCH GOLD B: 10u" INCH GOLD C: 15u" INCH GOLD D: 30u" INCH GOLD	T: TIN N: NICKEL P:TIN + DIMPLE Q: NICKEL +DIMPLE Z: ZINC (CHROMATIC)
5.MOUNTING METHOD	6.ACCESSORIES	7.SPECIAL OPTION	8.INSULATOR COLOR
A: BOARDLOCK (Z - SHAPE) B: RIVET W/BOARDLOCK (Z - SHAPE) C: RIVET ONLY D: NON - THREAD L - SHAPE E: RIVET W/NON - THREAD L - SHAPE F: 4#40 THREAD L - SHAPE G: RIVET W/4#40 THREAD L - SHAPE T: 4 - PRONG BOARDLOCK U:RIVET W/4 - PRONG BOARDLOCK	A: NON ACCESSORIES B: ADD SCREW (4.8 * 11.8) C: FIX SCREW (4.8 * 11.8) D: ADD SCREW (5.8 * 12.0) E: FIX SCREW (5.8 * 12.0)	A: 2.84mm STANDARD TYPE B: 2.54mm STANDARD TYPE C: 2.84mm EMI TYPE D: 2.54mm EMI TYPE	1. BLACK